

77303-H

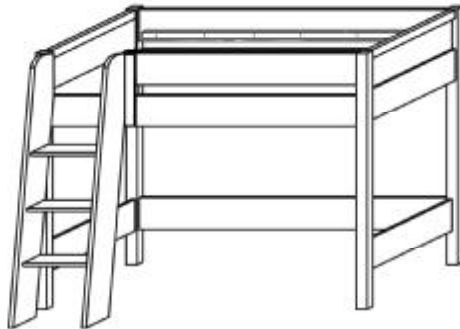

A = 18 x

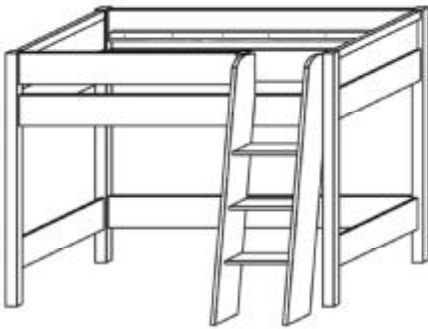

B = 18 x



C = 18 x

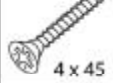

4 x 45

F = 2 x



G = 4 x



5x45

H = 2 x



I = 4 x



3,5 x 15

J = 3 x



3,5x40

K = 2 x



4x20

L = 4 x



3,5x 35

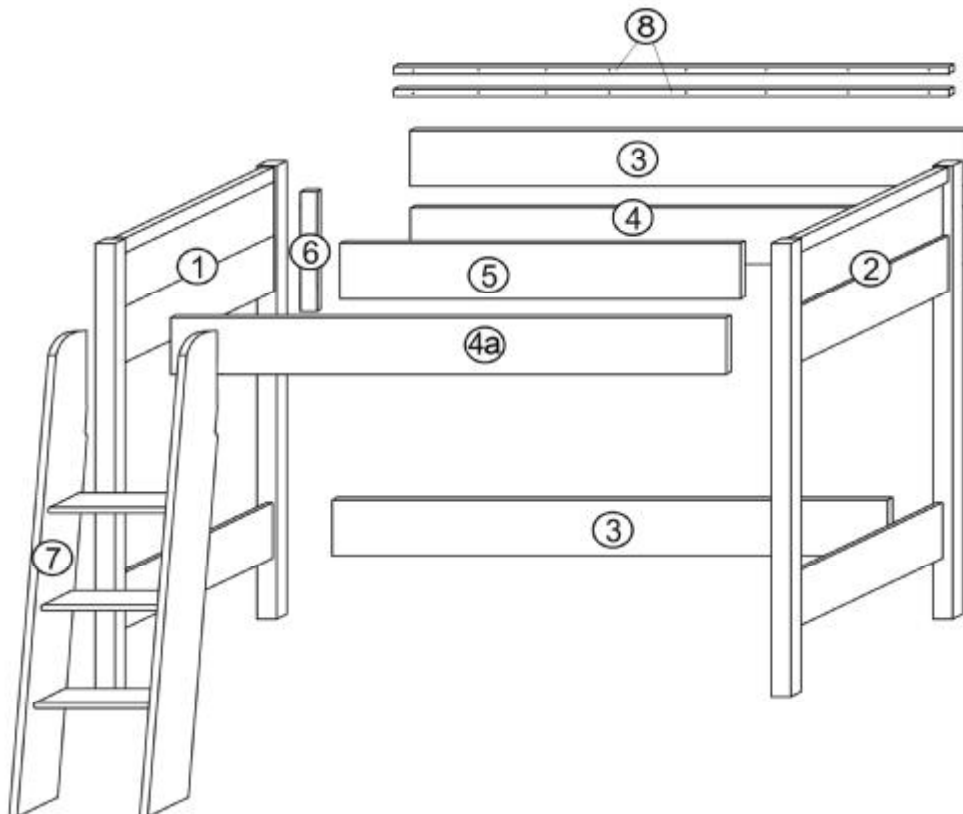

1

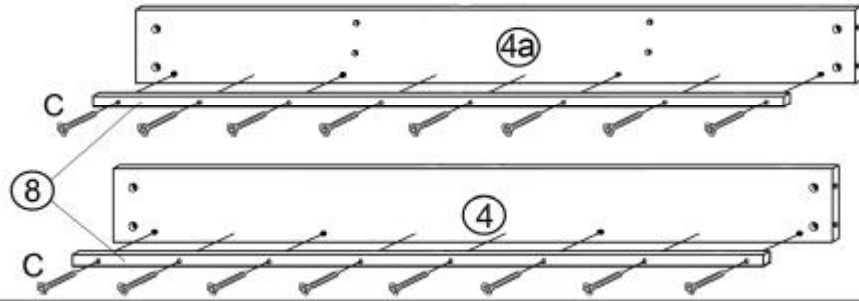

2

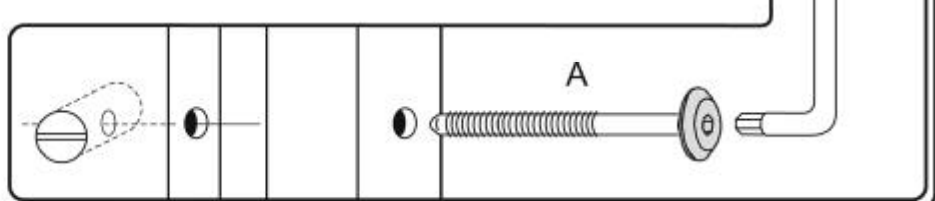
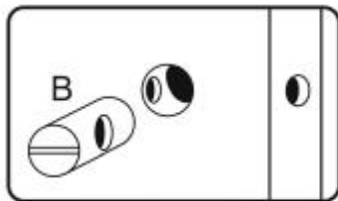
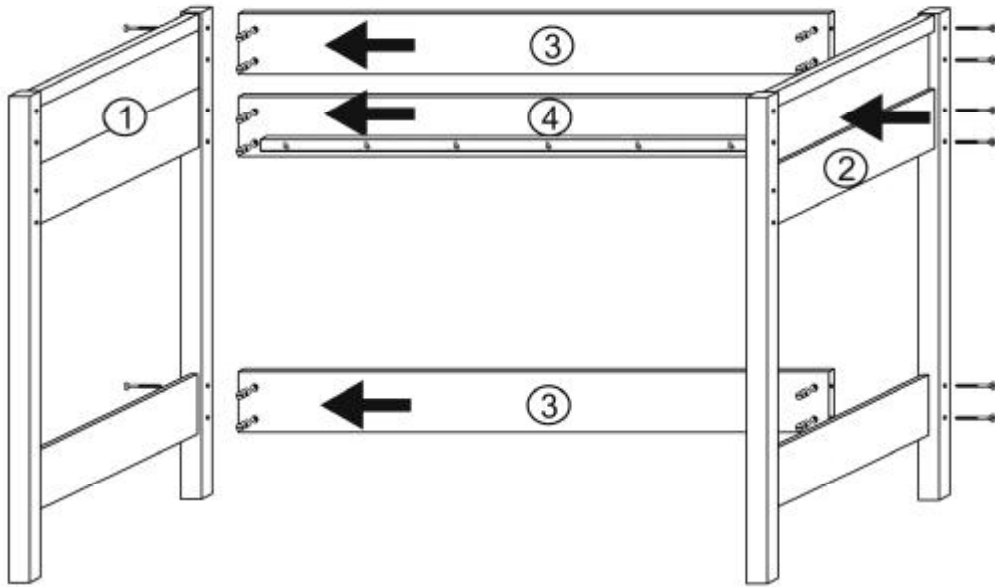

3

